

# **powrtrol**

## **Installation & Users Instructions**

Section	Page
1. Introduction	1
2. Dimensions	1
3. Specifications	2
4. Siting	2
5. Installation	2
6. Operation	2
7. Programming Time Switch	3
8. Commissioning And Testing	6
9. Wiring Diagrams	7
10. Connections To Powrmatic Heaters	11

## 1. Introduction

The Powtrol is a time and temperature controlled device to be used in conjunction with any Powrmatic warm air heater.

The standard unit contains a digital time switch, day thermostat and night thermostat together with a front panel mounted switch for setting Ventilation/Off/Winter operation.

Other available versions are:-

Powtrol RR - has a front panel mounted combined lockout indicator and reset switch.

Powtrol Hi/Lo - Has an additional day thermostat for controlling Hi/Lo burners.

Powtrol Optimum - An electronic thermostat with optimisation facility replaces the standard day thermostat.

## 2. Dimensions

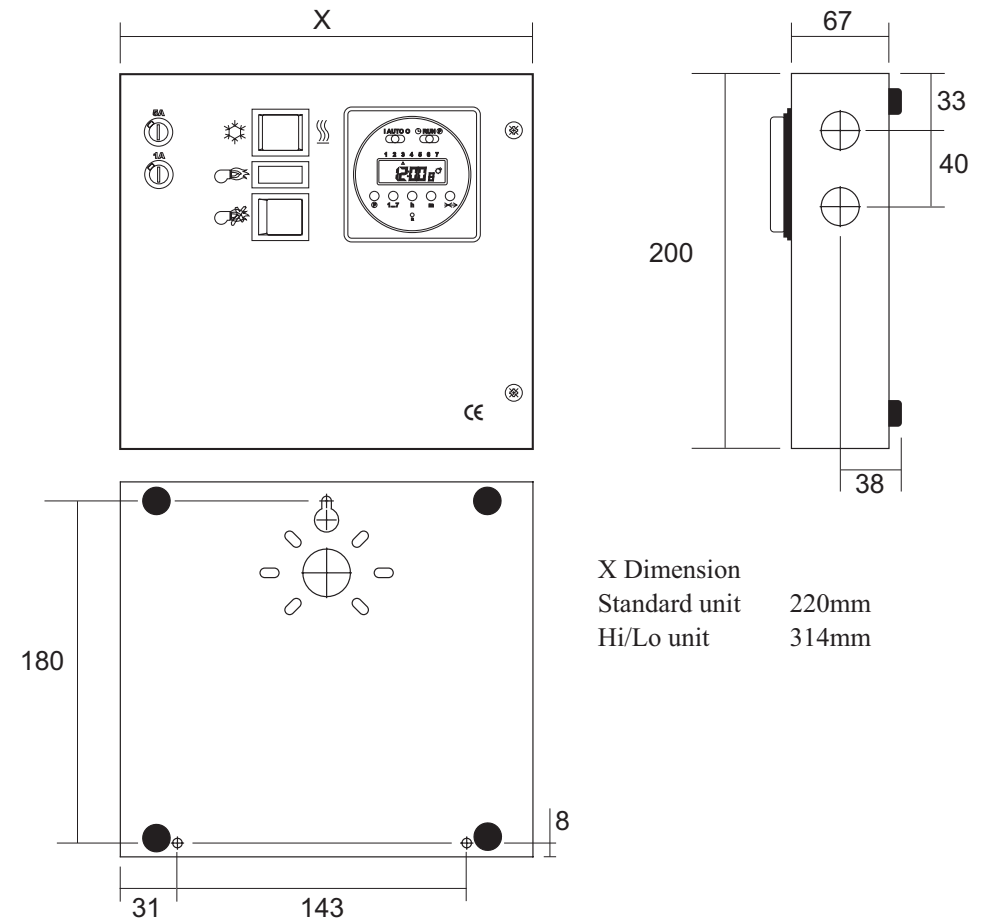

### 3. Specifications

Electrical supply	240V 50Hz 3A	
Summer/Winter switch	240V ac 10A (resistive)	2A (inductive)
Ambient temperature	-5°C - 55°C	
Operating temperature range	-20 - 30°C	
Thermostats	240V ac 10A (resistive)	2A (inductive)

### 4. Siting

The Powtrol must be sited at a point which is generally representative of the area in which the air temperature should be maintained. Areas which are draughty or subjected to direct heat (such as sun, radiators, heater outlets etc.), and areas with very little or no air movement should all be avoided.

### 5. Installation

#### IMPORTANT

The structure to which the Powtrol is to be mounted must be stable and vibration free.

#### 5.1 Mounting

Remove the two screws on the front of the unit and hinge lid upwards. Offer the unit up to its mounting position and mark the positions of the three fixing holes. Using suitable fixings secure the unit to the structure. The unit has facility for mounting direct onto a conduit box if required.

#### 5.2 Electrical Connections

##### IMPORTANT

Wiring external to the Powtrol must be in accordance with the I.E.E. regulations together with any local authority regulations which may apply. Wiring should be completed in conduit for which two 20mm entries are provided.

The Powtrol should be wired in accordance with the connection diagram below:-  
The mains supply for the Powtrol may be taken from the heater control panel or from a separate supply. In either case there must be a facility to allow for complete electrical isolation of the unit. The use of the Ventilation/Heating switch is optional for ventilation and is only necessary if specified by the end user or the unit is controlling a heater where the fan selection switch is not easily accessible.

**NOTE:** The mains supply for the heater **MUST NOT** be supplied via the Powtrol. External wiring should be carried out in cables of not less than 0.5mm<sup>2</sup> and Summer/Winter switch wiring of not less than 1.5mm<sup>2</sup>,  
Caution High voltage insulation tests on site wiring (i.e. Megger), must be carried out prior to making connections to the Powtrol. Continuity tests must only be made using a low voltage piece of test equipment (i.e. Avo).

### 6. Operation

#### 1. Ventilation/Off/Heating Switch

If the heating equipment being controlled by the POWRTROL is an air heater and this switch has been connected, then:

-In Heating position  The air heater will operate at the dictate of the timeswitch and thermostat.

-In Ventilation position  The air circulation fans of the air heater will run continuously, the timeswitch and thermostats having no control.

In the Off (centre) position the connected equipment will not operate

#### 2. Burner On Indicator

Will be illuminated when the control is calling for heat i.e. the burner is firing.

#### 3. Lockout Indicator/Reset switch (if fitted)

Will be illuminated when the burner is at lockout. Pushing the switch/indicator will reset the burner from lockout.

**Warning:** If the burner does not relight and run correctly after three lockout resets a Service Engineer should be called.

#### 4. Thermostats

##### Frost Thermostat (Night set back)

The frost thermostat (night set back) is set low and operates when the timeswitch is switched OFF.

##### Day Thermostat



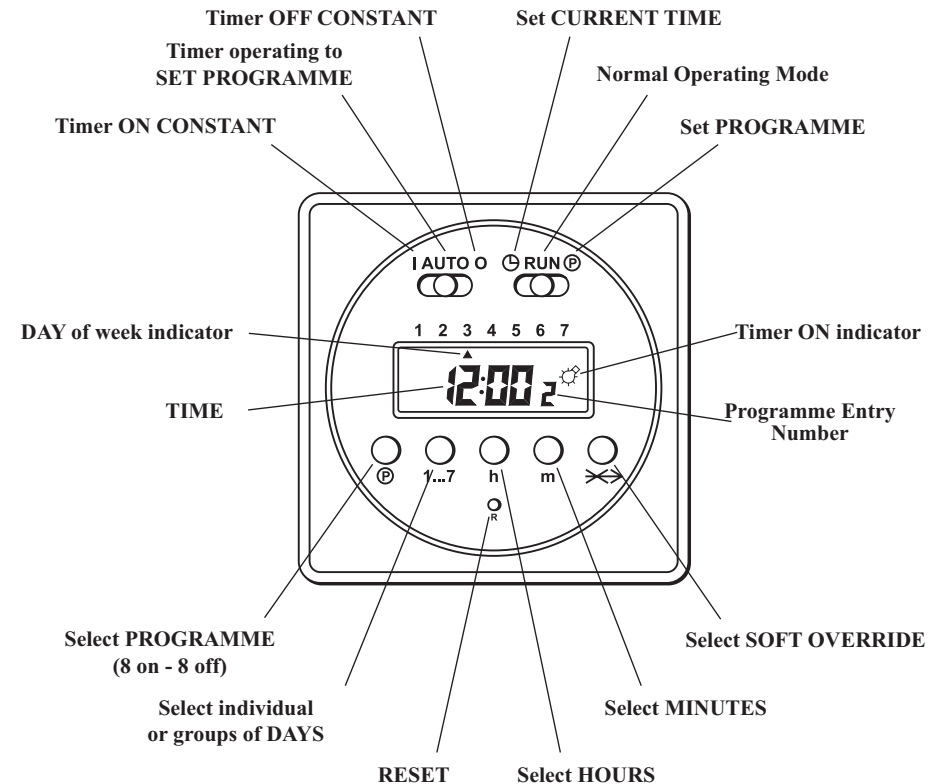

The day thermostat is set high (15°C-20°C)\* and operates when the timeswitch is ON.

\*Suggested range.



















## 7. Programming time switch

### Setting Time of Day:





- Select *clock* - 
- Set current time of day (24 hour clock) using   (hold down for 3 sec)
- Set current day using  (Monday = 1.... Sunday = 7)
- Select *run* - 

### Setting Programme:

- Select *programme* - 
- Set first programme switching **ON** time (1) using   ( in display indicates switches ON time)
- Set day or group of days using  First seven presses select individual days
 



Next press selects	1-5 (Monday-Friday)
“ “ “	6-7 (Saturday-Sunday)
“ “ “	1-6 (Monday Saturday)
“ “ “	1-7 (Monday-Sunday)
- Press  to select first programme **OFF** time (2)
- Set first programme switching **OFF** time using  
- Set day or group of days using  (this should match previous ON entry)
- Press  to select second programme **ON** () time (3)
- Continue to programme further switching times in a similar manner
- A maximum of **8 ON** () times and **8 OFF** times may be entered
- Review programme by pressing  repeatedly
- Individual programmes may be deleted by pressing and holding  + 
- Select  when all required programme times have been entered

### Programme Override:

- Select **I** -  to switch the timer permanently **ON** ()
- Select **0** -  to switch the timer permanently **OFF**
- Select **AUTO** -  to switch the timer to programme operation

### Soft Override:

- Pressing  will advance the programme to the next position

i.e.. if the timer is **ON** () pressing  will advance the timer to **OFF**, and vice- versa  
 Timer will revert back to normal programme operation at the next switching time

### Reset:

- Pressing  will clear any entered programmes, including the time of day.

### Example Programme:





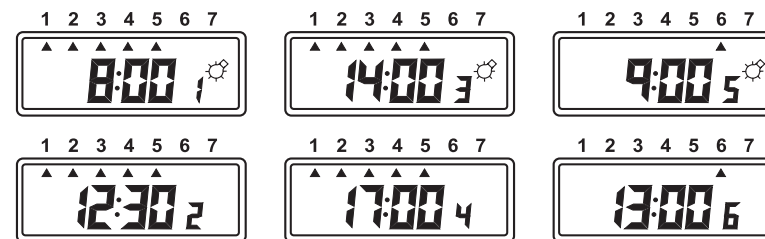



To programme a heating system to operate:

8.00am to 5pm Monday to Friday and Saturday 9.00am to 1.00pm.  
 The building is unoccupied from 12.30pm to 2.00pm every weekday



### Programme Tabulation:

Use this table to plan your heating programme

Prog No	Status	Day(s)	Time	Prog No	Status	Day(s)	Time
1	ON (  )			2	OFF		
3	ON (  )			4	OFF		
5	ON (  )			6	OFF		
7	ON (  )			8	OFF		
9	ON (  )			10	OFF		
11	ON (  )			12	OFF		
13	ON (  )			14	OFF		
15	ON (  )			16	OFF		

Notes:

## 8. Commissioning and Testing

### NOTE 1:

The Control Circuit and Ventilation/Heating circuit are both volt free. Reference must be made to the appliance wiring instructions. Refer to the appliance wiring diagrams for connection details of the burner lockout indicator/switch.

### 8.1 Functional Tests

Ensure that all electrical connections have been made and that the mains electrical supply is switched on.

After setting the programme on the timeswitch, carry out the following checks:-

1 Set Ventilation/Heating switch to Heating 》》》

2 Select **0** -  to switch the timer permanently **OFF**

3 Rotate day thermostat fully anticlockwise.

4 Turn frost thermostat clockwise until 'Burner On' indicator illuminates.

5 Turn frost thermostat anticlockwise until 'Burner On' indicator extinguishes

6 Select **I** -  to switch the timer permanently **ON** (⚙️).

7 Rotate day thermostat clockwise until 'Burner On' indicator illuminates.

8 Select **0** -  to switch the timer permanently **OFF**. 'Burner On' indicator extinguishes.

9 Select **I** -  to switch the timer permanently **ON** (⚙️)

10 Switch Heating/Off/Ventilation switch to Ventilation ⚙️. 'Burner On' indicator extinguishes.

11 Set timeswitch and adjust thermostats to clients requirements.

## 9. Wiring Diagrams

### 9.1 Standard Powtrol

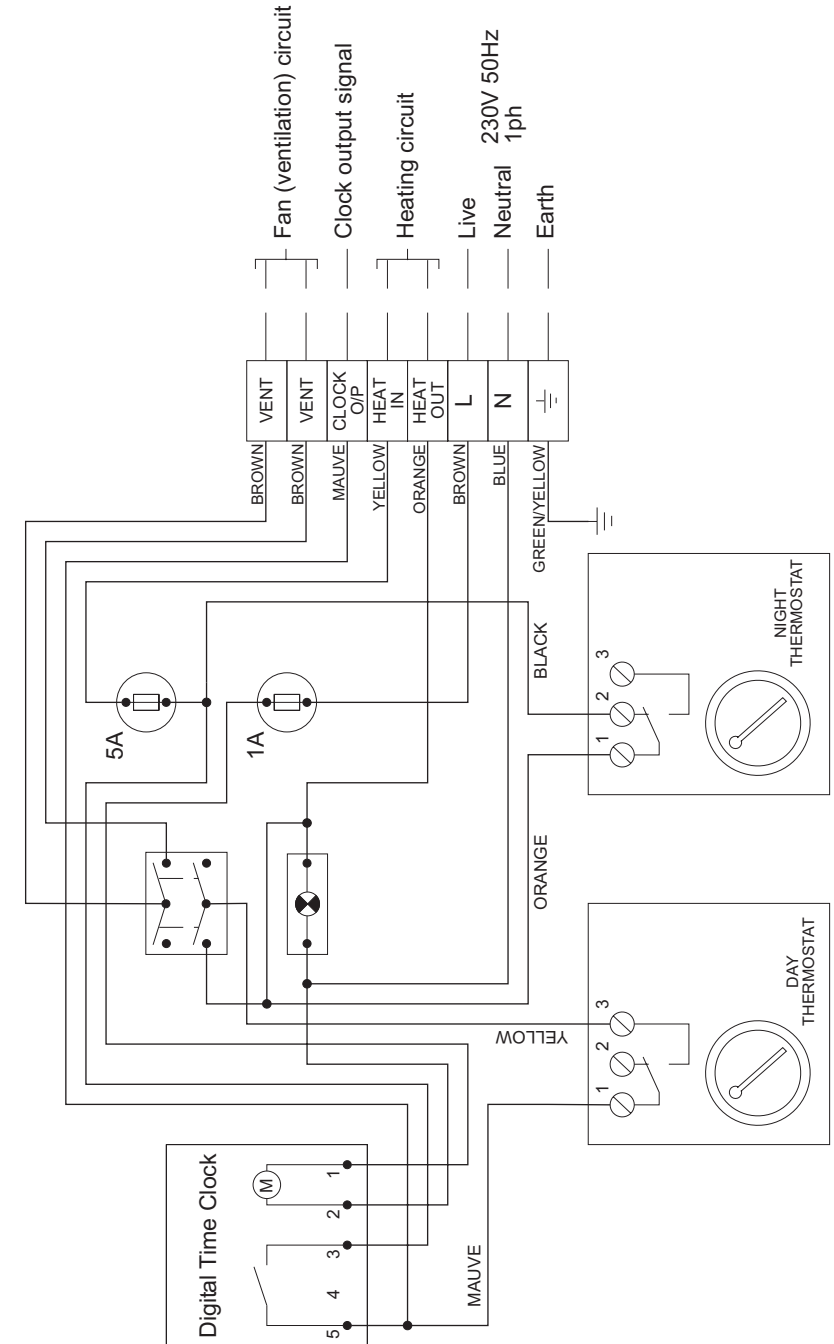

### 9.2 Powtrol with Lockout Indicator/Reset

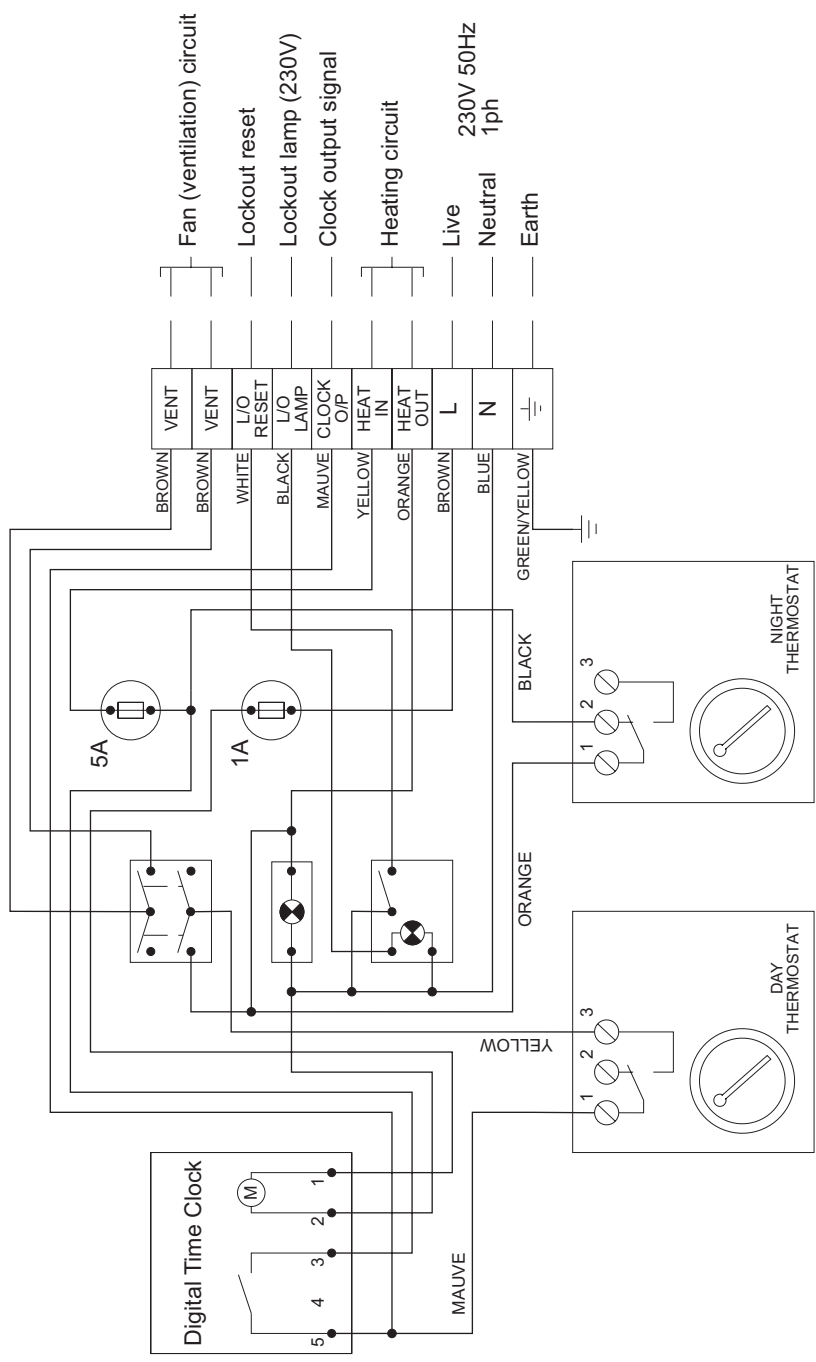

### 9.3 Hi/Lo Powtrol

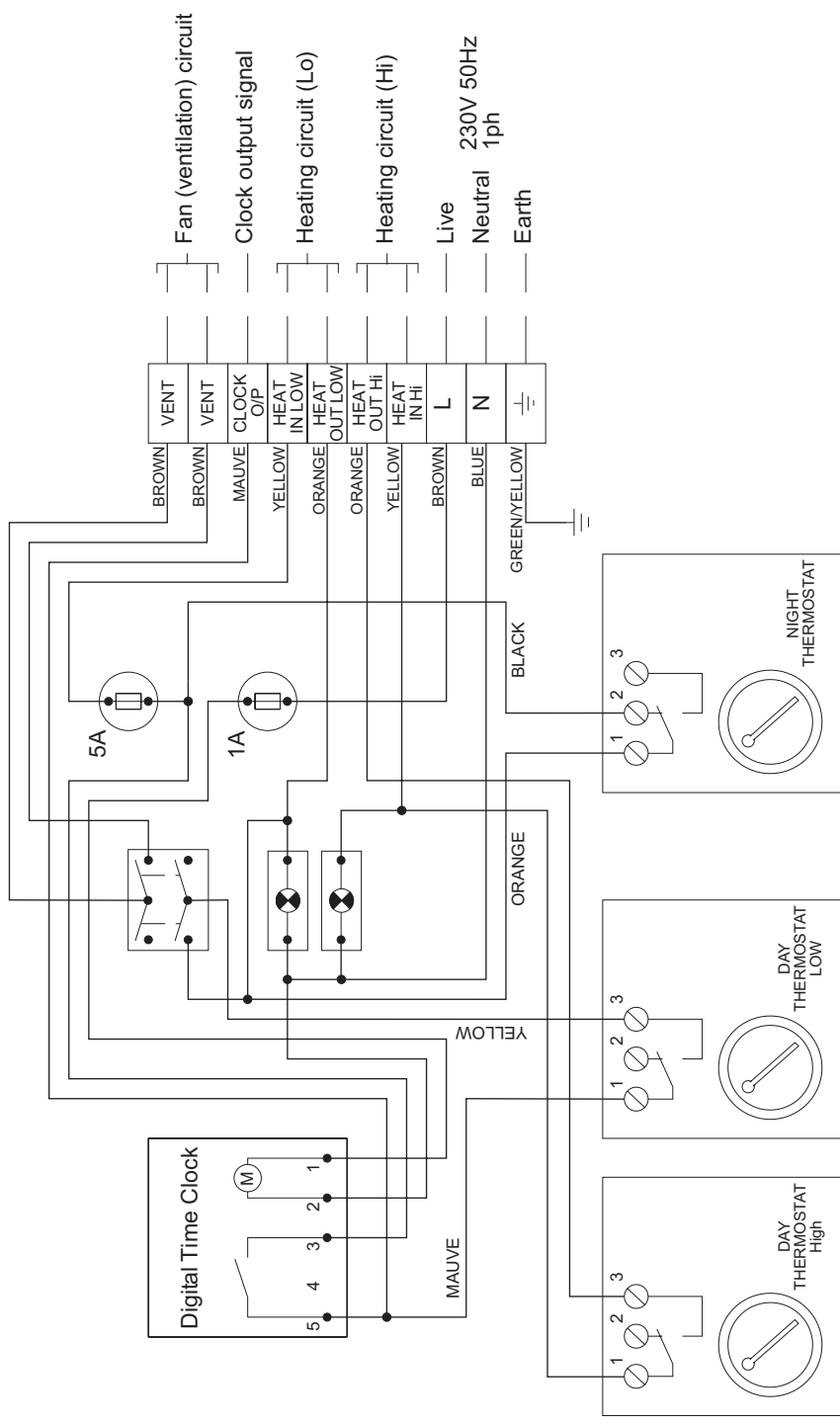

9.4 Hi/Lo Powtrol with Lockout Indicator/Reset

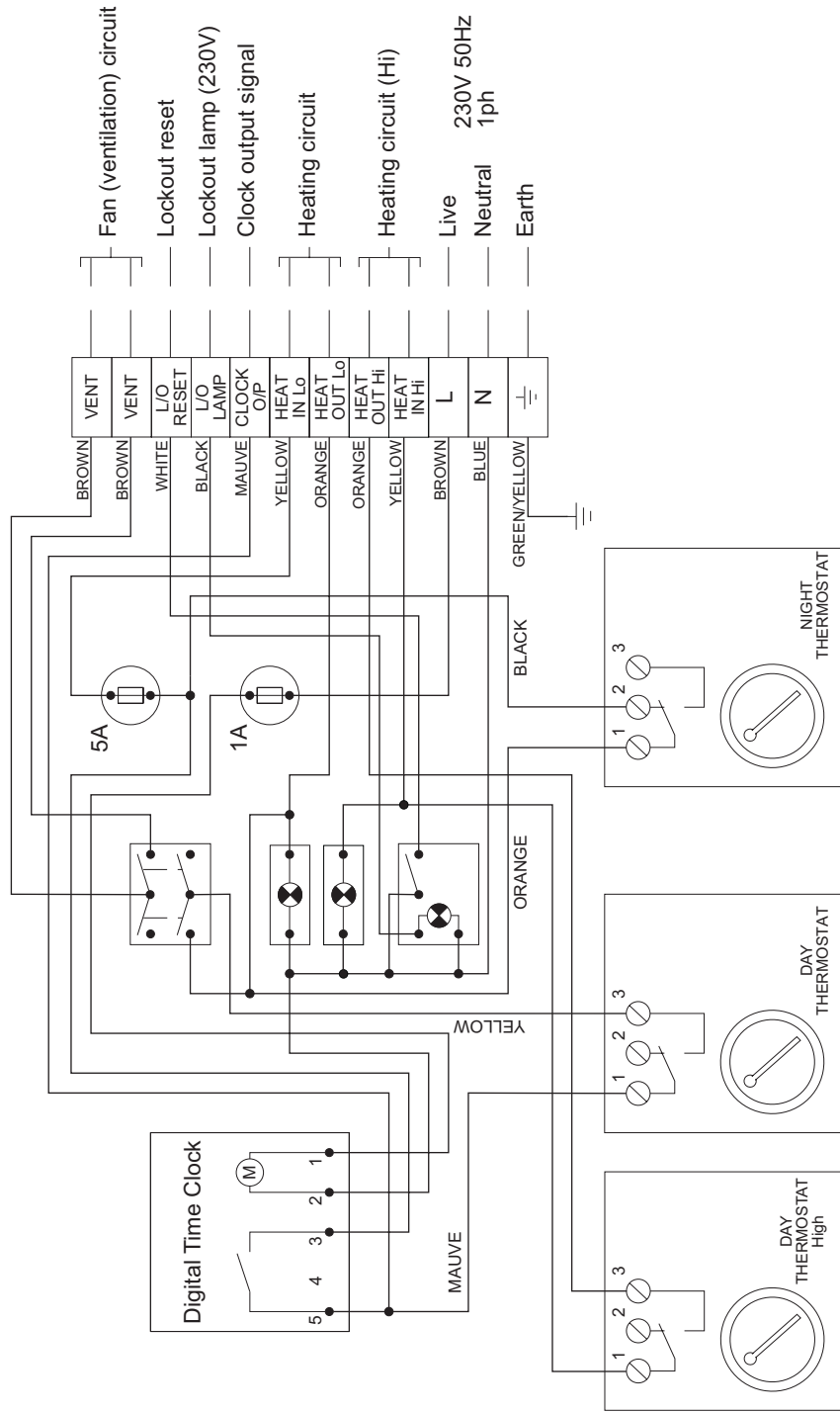

10. Connections to Powrmatic Heaters

Terminal allocations for connection to Powrmatic CP heaters fitted with screw type terminal blocks are as follows.

*Powtrol RR version shown*

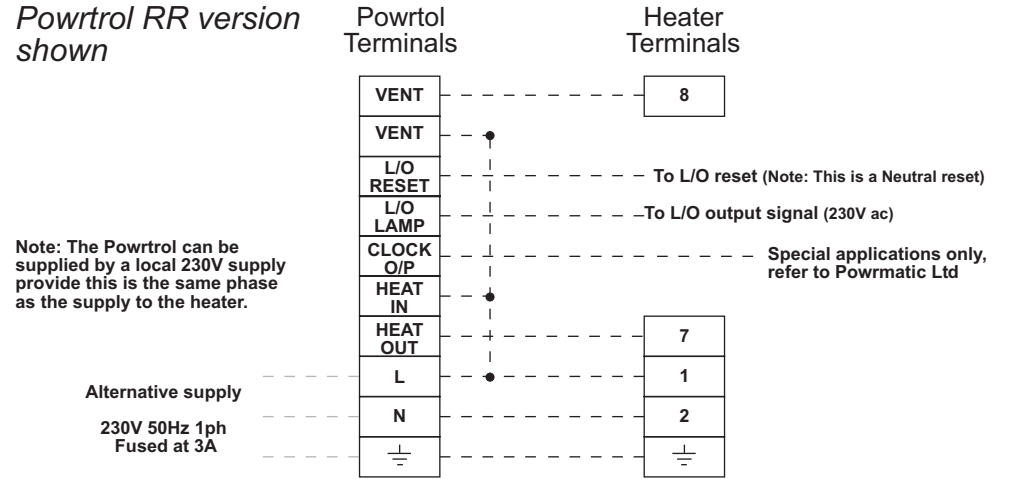

Terminal allocations for connection to Powrmatic NV heaters with Brahma control are as follows.

*Powtrol RR version shown*

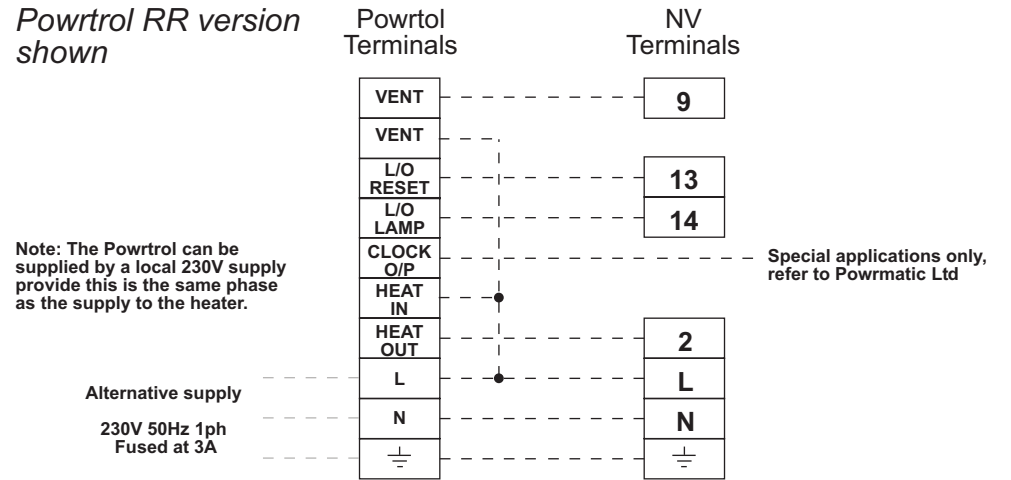



# **powrmatic**

**Hort Bridge, Ilminster, Somerset TA19 9PS**

TEL: +44 (0) 1460 53535

FAX: +44 (0) 1460 52341

Web: [www.powrmatic.co.uk](http://www.powrmatic.co.uk)

**A BSI REGISTERED FIRM (FM414)**

Every effort is made to ensure accuracy at time of going to press. However the company reserves the right to alter specifications without prior notice.